

Zonge NT-20
Multipurpose TEM Transmitter
Instruction Manual

June 2001

Zonge International
3322 East Fort Lowell Road, Tucson, AZ 85716 USA
Phone (520) 327-5501 Facsimile (520) 325-1588

Read This First

WARNING

Before operating your transmitter, we recommend that you read or at least skim the entire manual.

MAXIMUM INPUT VOLTAGE = 32 Volts D.C., i.e., two fully charged 12 volt batteries at 14.7 volts each for ZeroTEM. Use 12 V only for NanoTEM.

WATCH INPUT POLARITY AT BATTERY CONNECTORS, USE HEAVY GAUGE JUMPER BETWEEN BATTERIES, AT LEAST 8 GAUGE WIRE.

THERE IS A FIVE SECOND DELAY AFTER POWER IS TURNED ON FOR CIRCUITS TO STABILIZE, SEE CONTROL INFORMATION.

YOU HAVE TWO SECONDS AFTER PUSHING **RESET** TO PUSH **TRANSMIT**, OTHERWISE YOU MUST PUSH **RESET** AGAIN.

DO NOT OPERATE INTO A SHORT CIRCUIT, I.E., LESS THAN 0.5 OHMS.
THERE IS INTERNAL RESISTANCE ON THE ORDER OF 2.0 OHM.

DO NOT OPERATE THE TRANSMITTER WITH GREATER THAN A 5 VOLT DIFFERENCE BETWEEN INPUT AND OUTPUT VOLTAGE, except in NanoTEM mode at less than 3.5 amps.

ALWAYS SELECT LOOP SIZE BEFORE TRANSMITTING. Loop sizes larger than 100 meters should not be used in NanoTEM Mode.

NanoTEM OPERATION IS FROM A 12 VOLT SOURCE ONLY.

Decay time meter is not operational for NanoTEM. Use the default values in the GDP-32 manual, or use an oscilloscope to measure the decay times.

SECTION 1
DESCRIPTION OF THE NT-20
TRANSMITTER

1.1. INTRODUCTION4
1.2. ELECTRICAL & MECHANICAL SPECIFICATIONS.....5
1.3. NT-20 CASE.....6
1.4. FRONT PANEL.....7
1.5. INPUT OUTPUT PANEL9
2.1. OPERATING SUMMARY10
2.2. The NanoTEM Calibrate Box.....11

FIGURES

Figure 1 NT-20 Board Placement3
Figure 2 Front Panel.....6
Figure 3 I/O Panel6
Figure 4 NT-20 Calibrate Setup12
Figure 5 Plot of decay transient observed with Calibrator box....13
Figure 6 NT-Setup – GDP-3214
Figure 7 NT-32 Calibrate Setup15

1.1. INTRODUCTION

The NT-20 is a combined ZeroTEM / NanoTEM battery powered transmitter designed to transmit into a loop with a resistance of 10 ohms or less. It will transmit a time domain signal between DC and 512 hertz. It is capable of frequency domain operation over the same range.

The input voltage range is from 10 to 32 volts DC for TEM, and up to 14 volts DC for NanoTEM. The transmitter is designed for use in hostile environments and will work over a temperature range of -25°C to 65°C.

It uses individual touch switches for each function that are replaceable at the P.C. board level.

The NT-20 is a modular device with replaceable P.C. boards to upgrade or repair the instrument. Figure 1 shows board placement.

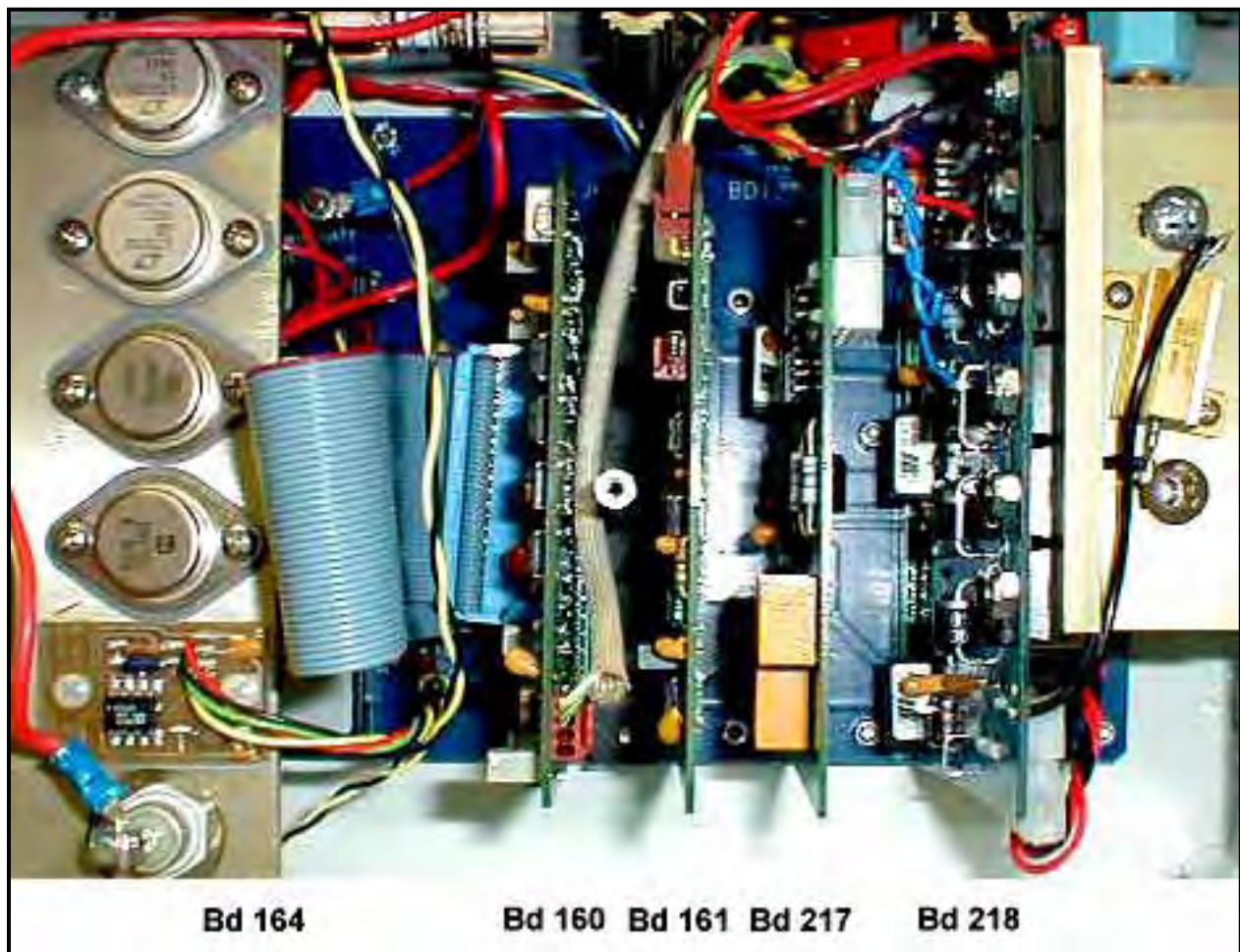

Figure 1: NT-20 Board Placement

1.2. ELECTRICAL & MECHANICAL SPECIFICATIONS

Description -	Variable voltage regulated 20 amp MOSFET / IGBT switched output transmitter.
Frequency Range -	DC - 512 Hz, 50% or 100% Duty Cycle
Turn-Off Time -	Less than 2 microseconds into a 20 x 20 meter loop.
Loop Size -	Any Length from less than 1 meter to 100 meters at 3.5 amps in NanoTEM mode. Up to 300 meters in ZeroTEM mode.
Survey Capabilities -	NanoTEM, TEM Loop driver, and small dipole IP
Power -	10 to 32 VDC Battery Powered, External Supply. Maximum of 14 VDC for NanoTEM
Output Voltage -	Adjustable from 1.75VDC to 5V below input voltage. Linear regulation for maximum noise rejection.
Temperature Range -	25°C to + 65°C.
Humidity Range -	0 to 100%
Switching Range -	250 nanoseconds into a resistive load, increasing as Inductance increases.
ZeroTEM Damping Circuit -	SIDAC protected output damps inductive spikes - 10 ohm resistance switched into loop to reduce turnoff time. 60 ohm loop damping resistance switched across loop on turnoff. Clamping SIDAC's to limit voltage rise to 200 volts or less across output in ZeroTEM mode.

Mechanical Specifications

Size:	29x21x19 cm. (11.5x8.5x7.5")
Weight:	6.8 kg (15 lb.)
Enclosure:	Heavy-duty, environmentally sealed aluminum case

Controls and Displays

LCD Voltmeters -	Input and Output Voltage, Output Current, Decay Time, and Internal Temperature.
LED Indicators -	Loop Size, Power ON, NanoTEM, Transmit ON, Polarity Plus or Minus, Meter Select. Over current, over voltage, over temperature.

Sealed Controls / Keys

Ten-Turn Voltage Adjust Potentiometer

Control Keys - See Page 6

1.3. NT-20 CASE

1) Case Lid

The case lid provides protection for the front panel of the receiver. The lid is removed by rotating it to the rear and disconnecting it from the hinge. The mil connector caps should be stored in the lid when the transmitter is in use.

2) Front Panel

The front panel contains the liquid crystal displays, the keys for operator interface, and individual LED lamps to report status of the NT-20.

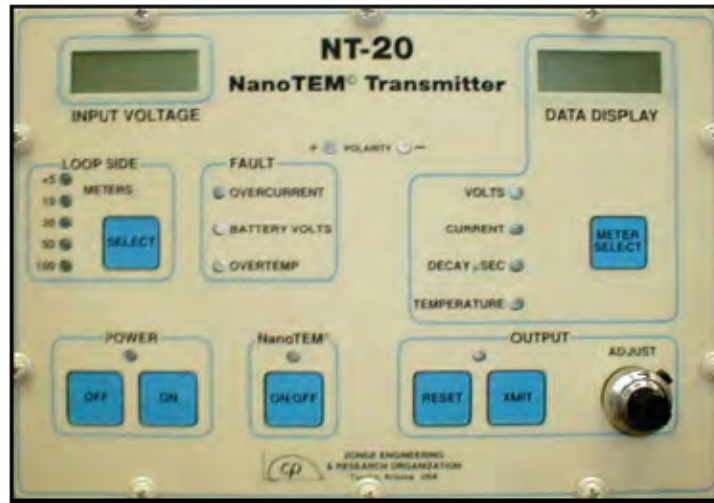

Figure 2: Front Panel

3) I/O Panel (Figure 3)

The back of the case contains the connectors to input power, control the transmitter switching and output power to the loop. The current sense connectors are also here. A 25 amp fuse for circuit protection is mounted internally.



Figure 3: I/O Panel

1.4. FRONT PANEL

(Figure 2)

The front panel contains the displays, control keys and voltage-adjust potentiometer. Operator control of the NT-20 is through the front panel.

Liquid Crystal Displays: There are two displays for transmitter status. The left-most display will indicate the battery input voltage at all times. The right display indicates different parameters as selected by the meter select switch. This meter can display regulated voltage to the output, output current, decay time in microseconds, and regulator heatsink temperature.

Transmitter ON and OFF

ON

OFF

These keys control power to the transmitter. After the transmitter is connected to the battery, pressing the **ON** key will energize the internal power supply. Pressing the **OFF** key at any time will reset the transmitter and turn off power to the internal supplies. The transmitter generates an internal 5 second delay each time it is turned on to allow the power supply to stabilize. The control circuits remain reset until this times out.

NanoTEM, ZeroTEM

**ON/
OFF**

This key controls the selection of NanoTEM or ZeroTEM operation. When the lamp is on, the transmitter is in NanoTEM mode. This will limit the output current to 4 Amps maximum. In ZeroTEM mode the maximum current is 20 Amps.

TRANSMIT and RESET

RESET

XMIT

These keys control the output of the transmitter. **RESET** must be pushed before Transmit. You have two seconds after **RESET** to press **XMIT**. This is to avoid an unwanted transmit if the key is accidentally pressed. Any fault condition will generate a reset condition.

METER SELECT

5)

This key controls which function is displayed on the **DATA DISPLAY**. It will cycle through the different functions and return to the top function each time.

- A) **VOLTS:** This is the voltage at the input to the output switch. It will be greater than the voltage across the loop due to the resistance of the devices in the output bridge.
- B) **CURRENT:** This is the actual output current measured across the output current sense resistor. It is sampled right before turnoff and sent to a true RMS converter. The output is buffered and sent to the **DATA DISPLAY**.
- C) **DECAY MicroSEC:** This displays the time it takes for the current to reach zero after the output is turned off. It displays the time in microseconds for ZeroTEM only. Use an oscilloscope for NanoTEM.
- D) **TEMPERATURE:** This displays the temperature in degrees Celsius at the regulator heat sink. The maximum temperature for operation is 65 degrees Celsius. A reset will be generated above 65 degrees.

SELECT

6) **LOOP SIDE:**

This key controls the damping resistor for loop size, the resistors are selected by the push button select switch. They vary from 90 to 1000 ohms. The loop side is from 5 meters to 100 meters. Select the closest loop size before transmitting. If you use a loop size in between the selection values, always use the smaller setting.

7) **POLARITY:**

These lamps represent the polarity of the output to the loop. When they are indicating, it shows that the output is switching.

8) **OVERCURRENT:**

This lamp lights when the output current has exceeded 25 amps, or 4 amps in NanoTEM. It also indicates that the transmitter has turned off. Push **RESET** to clear the indicator and either increase the loop resistance or decrease the regulated output voltage.

9) **BATTERY VOLTS:**

This lamp indicates an under or overvoltage condition which is set for less than 10 volts, or greater than 32 volts. It will also reset the transmitter and must be cleared by pushing **RESET** before operation can resume. Check for proper battery condition or voltage.

10) **OVERTEMP:**

This lamp comes on when the temperature of the regulator heat sink exceeds 65°C. and resets the transmitter. The temperature must fall below 65°C before operation can be resumed. If **OVERTEMP** occurs, use a lower current, add resistance to the loop, lower the input voltage, or turn the transmitter off between measurements.

1.5. INPUT OUTPUT PANEL

Rear of Case

(Figure 3)

- 1) **POWER:** This connector is for the DC input to the transmitter. The transmitter accepts voltages from 10 to 32 volts DC
- 2) **EXTERNAL CONTROL:** This input connector accepts signals from the XMT-32, GDP-32 or GDP-16 to control the NT-20. It accepts signals for period and duty cycle. The signal requirement is a 10 - 20 ma current loop.
- 3) **SET MODE:** This is a pushbutton switch used to select the NT-20 power-on mode. Use it to select the operation of the NT-20. When reset, the NT/ZT lamp will be in the state set by the mode switch.
- 4) **CURRENT SENSE:** These jacks provide an output from the current sense resistor. The green and yellow jacks are for ZeroTEM. Voltage is measured across the 0.1 ohm current sense resistor and provides an accurate current signal. In NanoTEM mode the blue and orange jacks are across a 1 ohm resistor is switched in for current sense
- 5) **OUTPUT:** These jacks are rated at 25 amps and provide connection to the loop. Good wiring must be used to avoid any voltage drop across the connections. The red jack is Positive ZeroTEM, and the blue jack is Positive NanoTEM. The black jacks are Ground.

SECTION 2 NT-20 TRANSMITTER OPERATION

2.1. OPERATING SUMMARY

This summary is intended to provide a basic startup procedure to enable the operator to try the basic functions of the transmitter without having to be fully conversant in its operation.

TRANSMITTER START UP

To power up the transmitter, first connect the power cable to the transmitter and then connect to a twelve volt battery of at least 20 ampere-hour capacity.

NOTE: A smaller capacity battery can be used for testing.

Press the **ON** switch, the control LED lamps should light in the following sequence.

Side - 20 meter, NanoTEM ON, Power **ON** and one of the meter select lamps. If any of the fault lamps are on, press **RESET**. The input voltage should be displayed in the left hand display. At this time the circuits will be activated and a delay of five seconds is generated to allow for circuits to stabilize. If all fault lamps are extinguished, the transmitter is ready to transmit. Use a digital voltmeter to check your loop resistance and make sure of continuity and a low loop resistance. Make sure the GDP receiver or XMT transmitter controller is connected and is **ON**. Plug in the loop to the output jacks using the supplied connectors to minimize contact resistance. Set the meter select to **CURRENT**. Turn the output adjust to minimum and press **RESET**. Within two seconds press **XMIT**, the contactor should drop in, and the output current should indicate on the data display. Turn the **OUTPUT ADJUST** knob to obtain the loop current needed. Press **METER SELECT** for the **VOLTS** display, and make sure the output voltage is within 5 volts of the input voltage.

WARNING

DO NOT OPERATE THE TRANSMITTER WITH GREATER THAN A FIVE VOLT DIFFERENTIAL BETWEEN INPUT AND OUTPUT IN THE REGULATED MODE.

The regulators will heat up at a rapid rate and shut down will occur at 65° Celsius.

It is permissible to operate up to 65°C.

2.2. The NanoTEM Calibrate Box

The NanoTEM Calibrate Box is an resistor-capacitor network that provides a load for the NT-20 Transmitter when operating in the NanoTEM mode which in turn generates a decay transient suitable for measurement in the NanoTEM decay windows.

SETUP

Figure 4 is a schematic diagram showing the setup for testing the GDP-32 with the NanoTEM Calibrate Box. Refer to the TEM section in your GDP 16/32 Manual for instructions about setting up the correct header information for the TEM. Follow the steps enumerated below and refer to the figure:

1. Connect the NT-20 transmitter outputs to the corresponding TRANSMITTER jacks (BLUE and BLACK banana jacks) of the NanoTEM Calibrate Box. Use the 60 cm twisted-pair cable provided with the calibrate box.
2. Plug the NT-I terminal connector (i.e., black double banana plug with single banana plug pigtail cable) into a GDP-32 input channel corresponding to a NanoTEM analog card. Plug the pigtail into the COM jack of the GDP-32.
3. Connect the RECEIVER outputs of the NanoTEM Calibrate Box to input channel containing the NT-I terminator plug, RED to RED and BLACK to BLACK. Use 10 cm jumper cables.
4. Connect the NT-20 power cable to a 12Vdc power source and the Transmitter I/O cable from the GDP-32 to the corresponding cable connector on the NT-20.
5. The results plotted in Figure 5 show the transient curve for 1.2 μs sampling and 1.6 μs sampling, respectively with the antenna delay set at 2 μs and the Tx delay set at 1.5 μs . The ALIAS filter was set to IN. The receiver moment was set for a standard 5mx5m loop ($R_{xM} = 250$). The output current of the transmitter should be adjusted to 1 A.

The recorded signal levels are normalized by current so it is important that the output current be set to one amp if decay curves are to be compared to those in Figure 5. Also remember that you are comparing curves with the same total delay time.

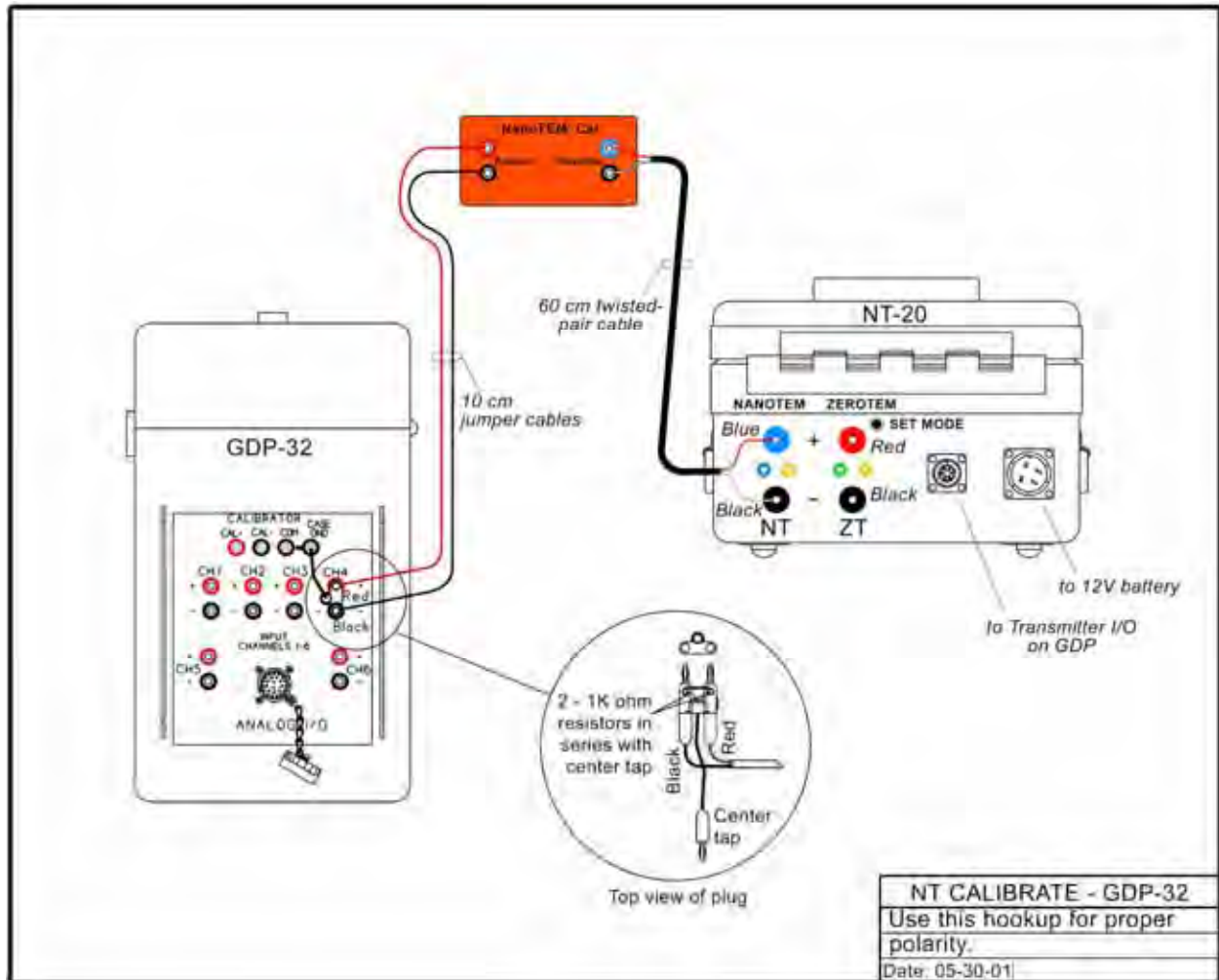

Figure 4: NT-20 NanoTEM Calibrate Setup

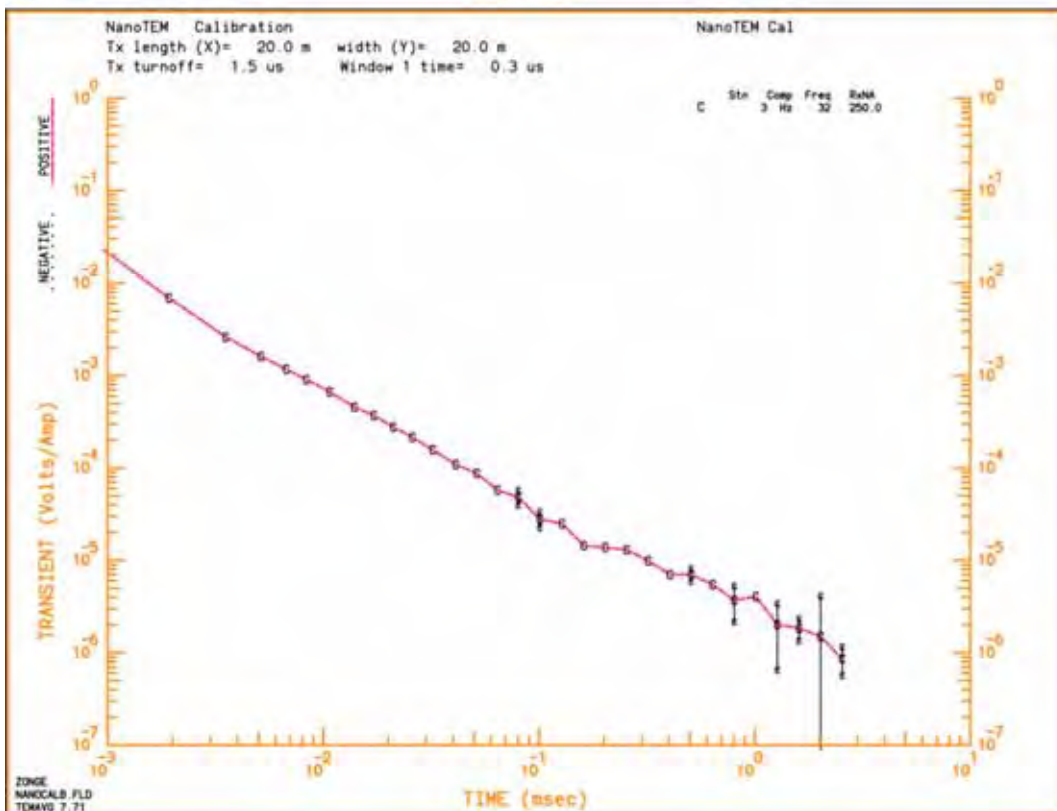
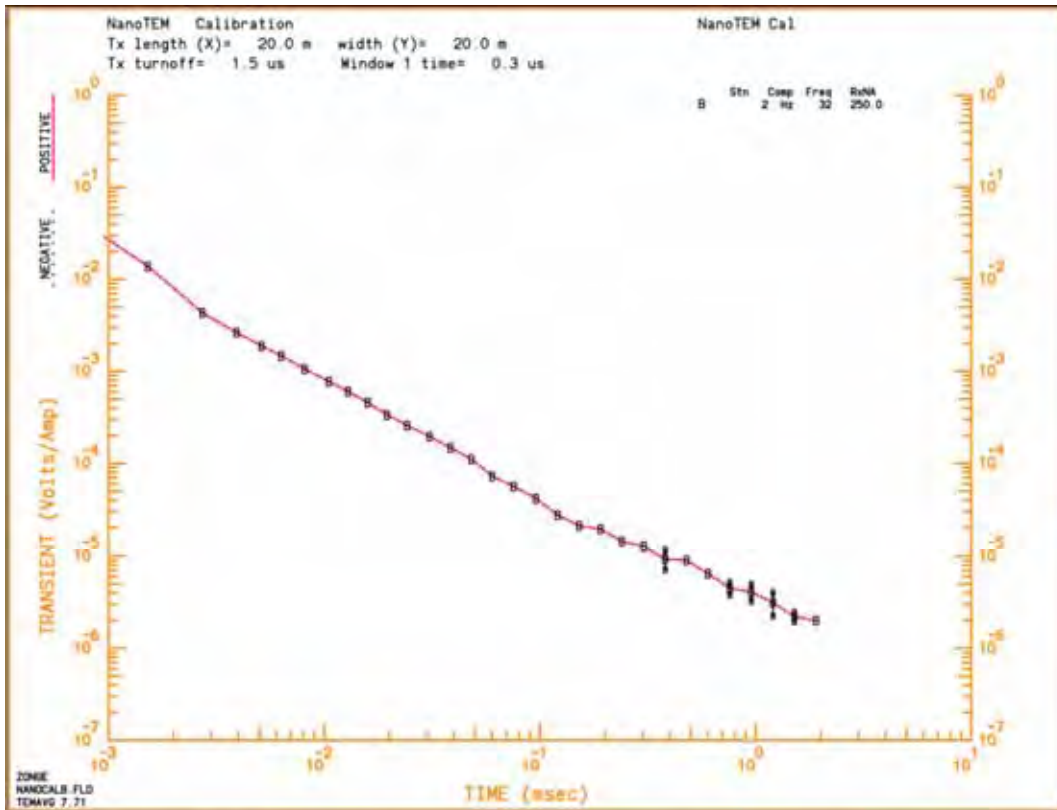

Figure 5: Plot of decay transient observed with NanoTEM calibrator
 A (top): 1.2 us sample interval, B (bottom): 1.6 us sample interval.

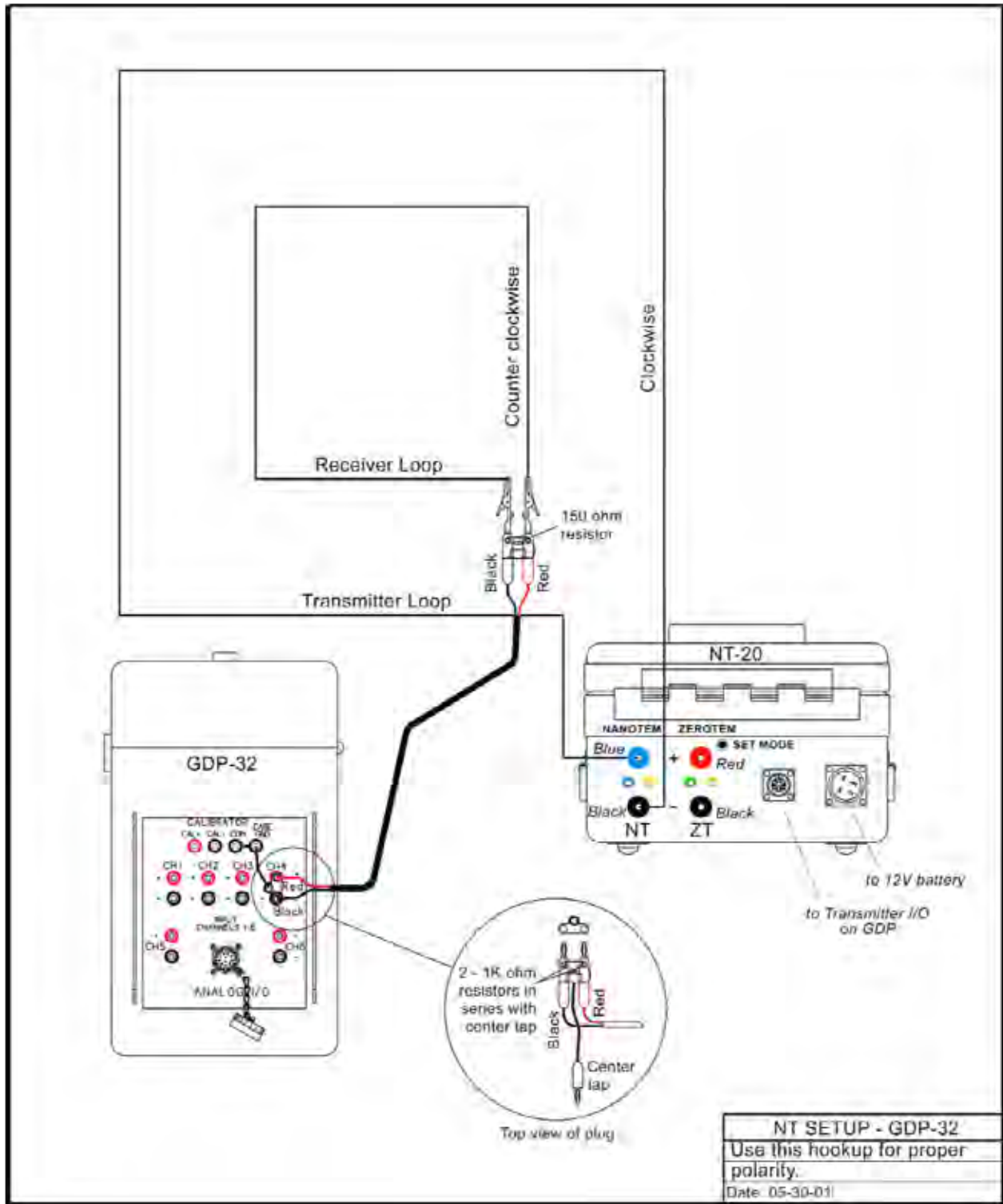

Figure 6: NT Setup – GDP-32

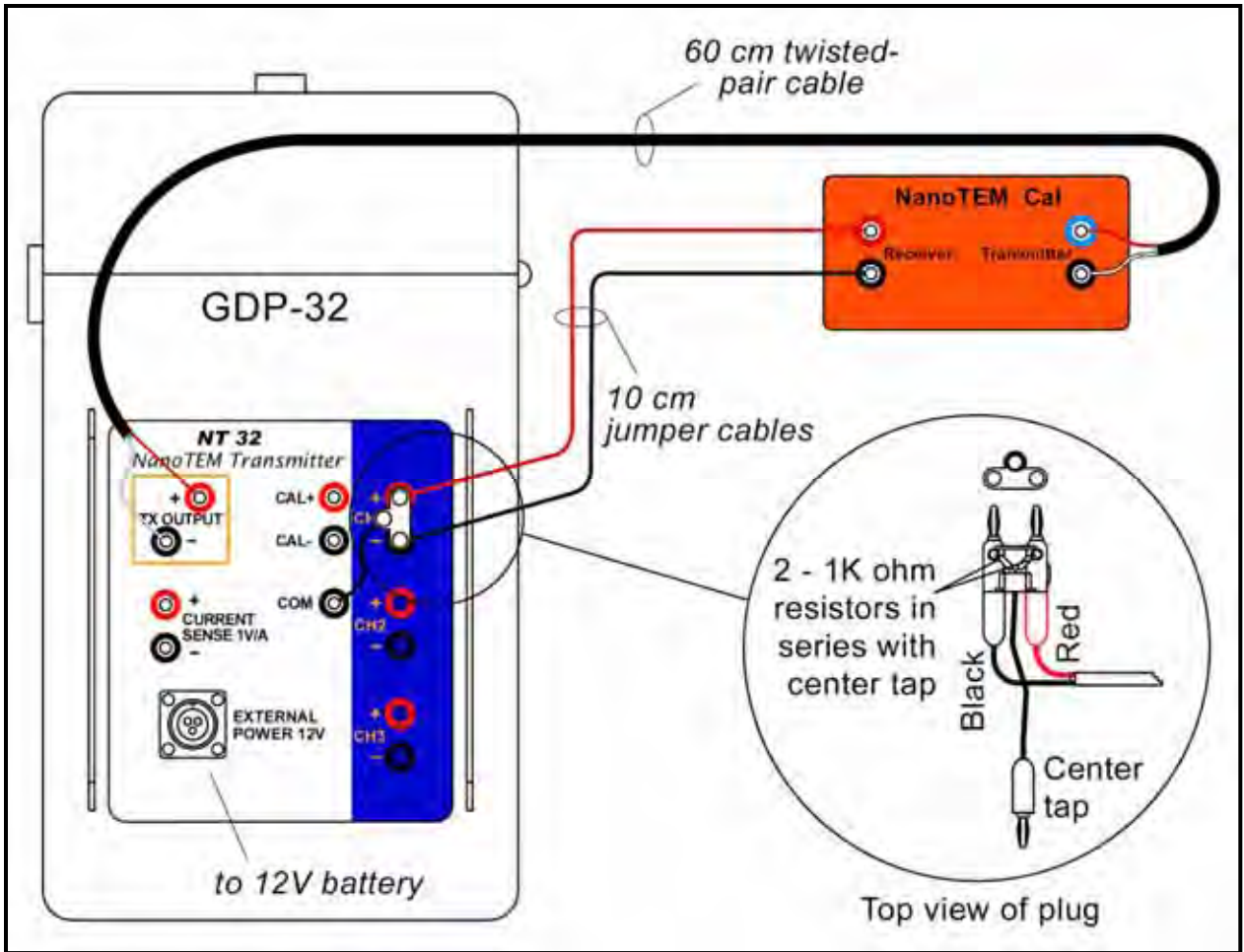

Figure 7: NT-32 NanoTEM Calibrate Setup